

Electric Instantaneous Water Heater

Operation and Installation Instructions



Models

KJE35

KJE45

KJE55

KJE60

Keep this instruction manual in a safe place once your unit is installed. You may need to refer to it for general instructions or future maintenance.

Our official website address

www.wintempshop.com

Install QR code



To obtain the benefit of this warranty, please email
support@wintempshop.com.

We will address your issue as soon as possible!

Please read and follow the installation and operation instructions carefully to ensure the long life and reliable operation of this appliance.

CONTENTS

IMPORTANT SAFETYINSTRUCTIONS	2
PRODUCT FEATURES	3
ELECTRICAL DIAGRAM	3
PRODUCTINNER STRUCTURE	4
TECHNICAL DATA	5
INSTALLATION GUIDELINE	5
INSTALLATION METHOD	6
OPERATIONINSTRUCTIONS	10
TROUBLE-SHOOTING	11
NORMAL MAINTENANCE	12
CORRECT DISPOSAL OF THIS PRODUCT	12
PACKING LIST	12

English

■ IMPORTANT SAFETY INSTRUCTIONS

1. THE INSTALLATION MUST BE IN COMPLIANCE WITH THE NATIONAL ELECTRICAL CODE AND YOUR LOCAL ELECTRICAL AND PLUMBING CODES.
2. This appliance must be EARTHED.
3. Install or locate this water heater only in accordance with the provided installation instructions.
4. Use this water heater only for its intended purpose as described in this manual.
5. Contact a qualified electrician to have the unit properly installed for models that are not equipped with a plug.
6. This appliance is not intended for use by persons (including children) with reduced physical, sensory, or mental capabilities, or lack of experience and knowledge, unless they have been given supervision or instruction in the use of the appliance by a person responsible for their safety.
7. This appliance **MUST** be permanently connected to a fixed circuit breaker and must be installed vertically (excluding models equipped with a plug). **DO NOT** install this appliance near flammable materials or strong magnetic fields. Children should be supervised to ensure that they do not play with the appliance.
8. This appliance must not be switched on if there is a possibility it may be frozen, as this could result in serious damage to the unit. Wait until you are sure that it has completely thawed before switching it on.
9. Please feel the hot water temperature at the outlet with your hand to ensure it is suitable and avoid scalding.
10. Before connecting pipes to the water heater hoses, it is extremely important to FLUSH the pipes to wash away all plumbing paste or residue in the pipes.
11. If the wire is damaged, you must contact a qualified electrician to replace it with a dedicated wire from our authorized dealers.
12. The water relief valve should work periodically to remove calcium carbonate deposits.
13. The drainpipe connected to the water relief valve should be installed continuously downward in a frost-free environment.
14. The faucet nozzle must be descaled regularly.

WARNING: Do not switch on if there is a possibility that the water in the heater is frozen.

■ PRODUCT FEATURES

The electric instantaneous water heaters incorporate patented heating technology with multiple safety devices. The unit offers the following features:

1. Sleek appearance and unlimited hot water supply.
2. High-strength ABS splash-proof casing.
3. Easy to install, the heater can be fitted above or beneath the sink.
4. Easy to operate, the heater delivers hot water at a constant temperature.
5. Micro-computer control with patented heating technology. Water is completely separated from electricity through multiple layers of composite nano insulation material.
6. Prevents scalding by stopping the appliance if the outlet water temperature reaches or exceeds 75°C. The appliance resumes operation automatically once the temperature drops to a safe level.
7. If there is an issue with the outlet temperature sensor, the heater stops working and displays error code E4.
8. If the heating temperature exceeds 95°C, the power is automatically cut off.

■ ELECTRICAL DIAGRAM

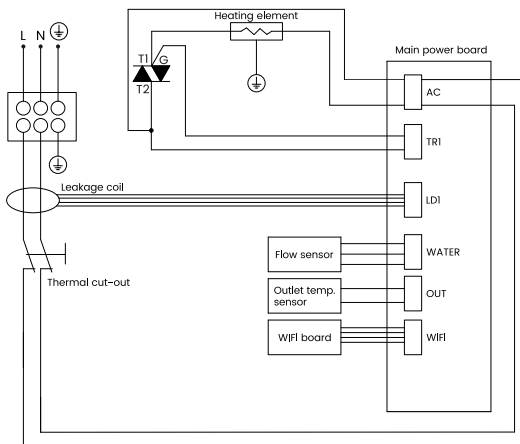

■ PRODUCT INNER STRUCTURE

3.5/4.5KW

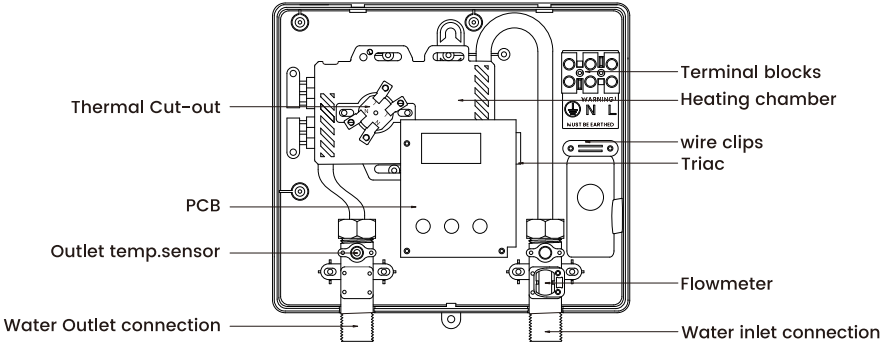

5.5/6.0KW

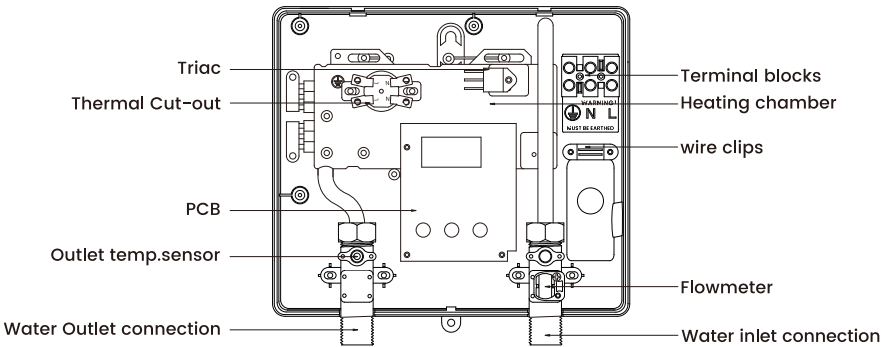

■ TECHNICAL DATA

Model	KJE35	KJE45	KJE55	KJE60
Voltage	230V			
Wattage	3500W	4500W	5500W	6000W
Rated Current	15,2 A	19,6 A	23,9 A	26 A
Min. required circuit breaker	20A	32A	32A	32A
Min. wire size	1,5mm ²	2,5mm ²	2,5mm ²	4mm ²
Min. water flow to activate unit	1,0 L/min	1,2 L/min	1,2 L/min	1,5 L/min
Temp. setting range	30-60°C			
Thermal cut-out (Manual reset)	95°C			
Over Heating protection	75°C			
Working pressure	0,02-0,6 Mpa			
Product Dimensions	226 x 196 x 78 mm			
Water connections	G1/2"			

■ INSTALLATION GUIDELINE

The installation must comply with the National Electrical Code, as well as local electrical and plumbing codes.

1. Ensure the appliance is intact and all fittings are complete.
2. Confirm that the main power supply, water pressure, grounding condition, ammeter, and wire meet the installation requirements.
3. The appliance must be connected to properly grounded, dedicated branch circuits of the correct voltage rating. Grounding must be established at the circuit breaker panel.
4. This appliance **MUST** be permanently connected to a fixed circuit breaker. Switch off the circuit breaker when the heater is not in use.
5. **DO NOT** install this appliance near flammable materials or strong magnetic fields. The appliance can be installed above or under the sink and must be mounted vertically near the water fittings. Test the unit by connecting the water supply before switching it on.

■ INSTALLATION METHOD

General:

The mini tankless electric water heater can be used for hand washing or in the kitchen and can be installed either above or below the sink.

Mounting the Unit:

Locate an appropriate place on a section of the wall as mentioned above.

Step 1: Front (Figure 1) and back (Figure 2) of the appliance.

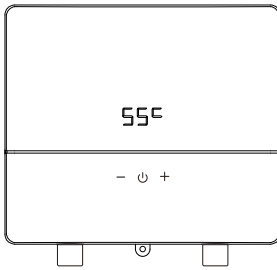

Figure 1

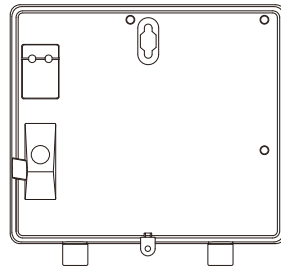

Figure 2

Step 2: Use a cross screwdriver to remove the screw at point A, then open the front case (Figure 3).

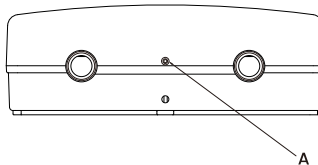

Figure 3

Step 3: Connect the power cable to the terminals marked L (Phase), N (Neutral) and E (Earth) at the indicated positions (Figure 4). Mount the cover and tighten the screws. Ensure that cables and wires of the correct size are installed to avoid smoke development and fire hazard (Figure 5).

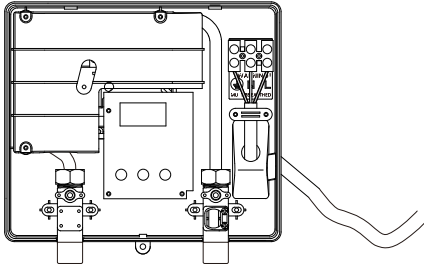

Figure 4

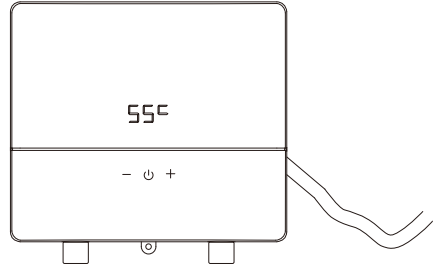

Figure 5

Step 4: Drill two holes with a diameter of 6.00 mm.

Upright installation: The distance between the holes is 181 mm (Figure 6).

Upside down installation: The distance between the holes is 159.5 mm (Figure 7).

Insert plastic dowels into the holes.

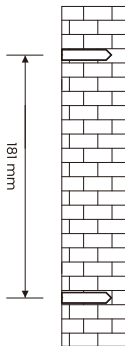

Figure 6
Upright installation

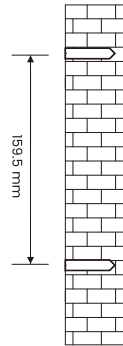

Figure 7
Upside down installation

Step 5: For upright installation, nail through the upper hole and leave a length of 6.5 mm exposed (Figure 8). For upside down installation, nail through the lower hole and leave a length of 6.5 mm exposed (Figure 9). Secure the device to the wall with the nail.

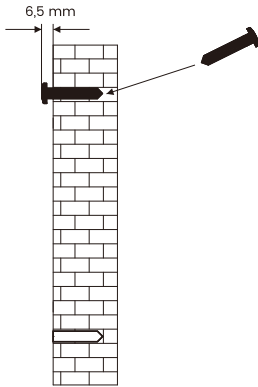

Figure 8
Upright installation

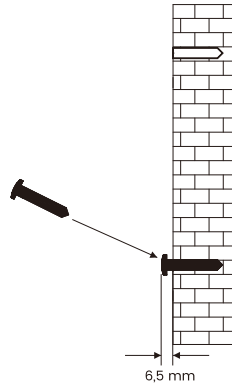

Figure 9
Upside down installation

Step 6: Hang the device on the screw in the wall and secure it with another screw. (Figure 10) (Figure 11)

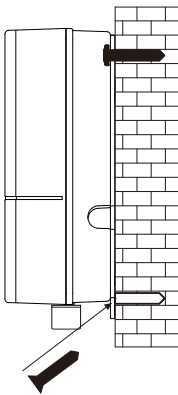

Figure 10
Upright installation

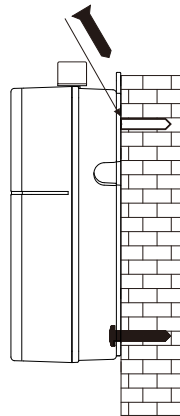

Figure 11
Upside down installation

Step 7: Connect the water pipe to the water inlet and water outlet connections. Remember to install the rubber seal ring. (Figure 12) (Figure 13)

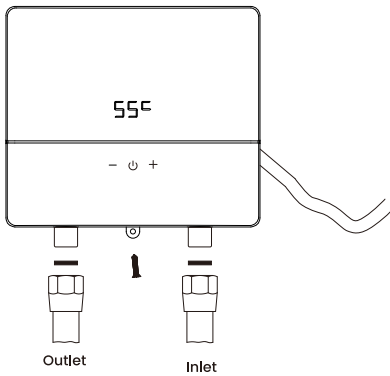

Figure 12
Upright installation

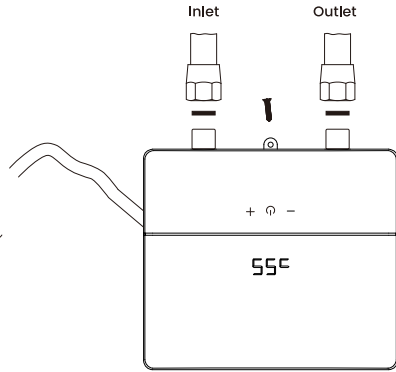

Figure 13
Upside down installation





Water Connections:

1. All water pipes must comply with national and applicable state and local water pipe codes.
2. Regardless of whether the appliance is installed upright or in a handstand position, please connect the inlet connection (indicated by a blue arrow) to the cold water inlet pipe; connect the outlet connection (indicated by a red arrow) to the hot water outlet pipe.
3. The unit should be connected directly to the main water supply. Flush the pipe with water to remove any debris or loose particles.
4. It is required to use G1/2" water connections to fit the appliance. Please connect the inlet and outlet pipes accordingly. (Figure 12)(Figure 13)
5. Please remember to install rubber seal rings at the connections. Once all water connections are completed, check for leaks and take corrective action before proceeding.

Electrical Connection:

1. All electrical work must comply with national, state, and local electrical codes.
2. All units must be connected to a properly grounded dedicated branch circuit with the appropriate voltage rating.
3. When feeding the cable to terminal blocks or a circuit breaker, ensure that the metal wire ends and the terminal blocks make complete contact. Then, tighten the screws to ensure that the full current can flow through.
4. Before starting any work on the electrical installation, make sure the main breaker panel switch is OFF to avoid any danger of electric shock. Ensure that all mounting and plumbing are completed before proceeding with the electrical hook-up.

■ OPERATION INSTRUCTIONS

1. Turn on the circuit breaker to supply electrical power to the unit.
2. Open the water faucet for a few minutes until the water flow is continuous and all air is expelled from the pipes. Ensure the unit is operational after turning on the breakers.
3. Once powered, you will hear a beep sound and see the LED light up for 2 seconds without any other display, indicating the appliance is in standby mode.
4. Press  the ON/OFF button to operate the appliance. When ON, the LED will show the set temperature for 2 seconds, then display the actual outlet water temperature. After 2 seconds, the screen will switch to screen saver mode and the display will turn off. Touching the screen will reactivate the display.
5. Press the  and  buttons to adjust the outlet temperature. The range is 30–60°C.
 - If the unit has been inactive, turning it on might initially release a short burst of very hot water. Let the water run for a few seconds to stabilize the temperature. Always check the temperature by hand before showering.
 - If not in use during winter, completely drain the unit to prevent freezing.
 - Please regularly clean the inlet filter and the faucet nozzle to ensure a smooth water flow.
6. In off mode, press and hold the  and  buttons simultaneously for 3 seconds to invert the LED digital display.
7. If the outlet temperature reaches 70°C or higher, the heater will stop until the temperature drops to 50°C, then restart automatically. If the temperature reaches 75°C, the LED will display error "E1".
8. The unit includes an automatic memory function to maintain the last set temperature, simplifying operation upon startup.

■ TROUBLE-SHOOTING

Problem	Possible Causes	Corrective Actions
Inlet and outlet fittings leaking.	Fittings not tight.	Tighten fittings.
	Rubber washer worn out.	Replace the rubber washer.
LED no signal.	Power not connected.	Connect power to the unit.
	LED damaged.	Replace LED.
Functional keys not working.	No water output from faucet.	Open valve to release water.
	Water pressure too low.	Open valve to increase pressure.
	Key or PCB damaged.	Replace key or PCB.
Water too hot.	Temperature set too high.	Set a lower temperature.
	Water flow too small.	Increase inlet water flow.
Water too cold.	Temperature set too low.	Set a higher temperature.
	Water flow too high.	Reduce water flow.
Outlet water flow decreasing	Inlet strainer or faucet clogged.	Clean strainer and faucet.

Error Display:

If the system detects an error, the error code will be displayed on the screen as follows:

Error	Possible Cause	Solution
E1	Outlet temperature is over 75°C.	Increase inlet water flow.
		Contact local dealer.
E2	Electricity leakage	Contact local dealer.
E4	Outlet temperature sensor failure.	Contact local dealer.

■ NORMAL MAINTENANCE

Note: Do not attempt to repair this water heater yourself; always call a service technician for assistance. Ensure the power supply is shut off before beginning any maintenance tasks.

Although regular maintenance is not required, the following procedures are recommended to ensure consistent water flow:

1. Periodically remove scale and dirt that may accumulate in the faucet nozzle.
2. There is a built-in filter screen at the inlet connection that should be cleaned occasionally. Ensure that the water flow is turned off before starting this task.

■ CORRECT DISPOSAL OF THIS PRODUCT

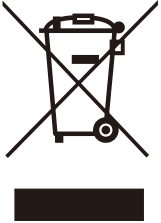
CB CE	
	<p>This symbol indicates that this product should not be disposed of with regular household waste across the EU.</p> <p>To prevent potential harm to the environment or human health from uncontrolled waste disposal, recycle this product responsibly to promote sustainable reuse of material resources.</p> <p>To return your used device, please use the designated return and collection systems, or contact the retailer where the product was purchased.</p> <p>They can ensure that this product is recycled in an environmentally safe manner.</p>

■ PACKING LIST

Item	Unit	Quantity
Electric Water Heater	Unit	1
Rubber Plug and Screw	Piece	1
Operation and Installation Instructions	Copy	1